



NEW K-CLASS  
BENCHMARK IN TECHNOLOGY  
AND DESIGN

WELCOME  
TO THE BIZERBA

OPEN  
WORLD



OUR  
EXPERIENCE



# SETS STANDARDS

We are a family-owned company guided by a commitment to tradition, sustainability and responsibility. Nowadays, based on our core competence of slicing and weighing technology, we offer our customers the industry's largest and most unique range of products and solutions as hardware, software and services, anywhere in the world.

As a global acting technology company, we allow ourselves to be led by the aim and the requirement to achieve the best possible results in terms of ergonomics, hygiene, safety and efficiency. We believe we have a role to play in shaping our markets, and are

continually setting new industry standards. In close collaboration with our customers and against a backdrop of technological advancement, we are working to improve our products on a daily basis – resulting in innovations which become new standards.

In order to continue to live up to these requirements, we focus on the highest possible quality standards and internationally recognized technology standards in our development and manufacturing work. We aim to provide our customers with easy-to-use and optimized purpose-built products and solutions for each individual

application. This is how we best support our customers in achieving maximum efficiency and profitable growth.

**OUR EXPERIENCE SETS STANDARDS.  
THAT'S WHAT MATTERS TO US.  
BIZERBA.**

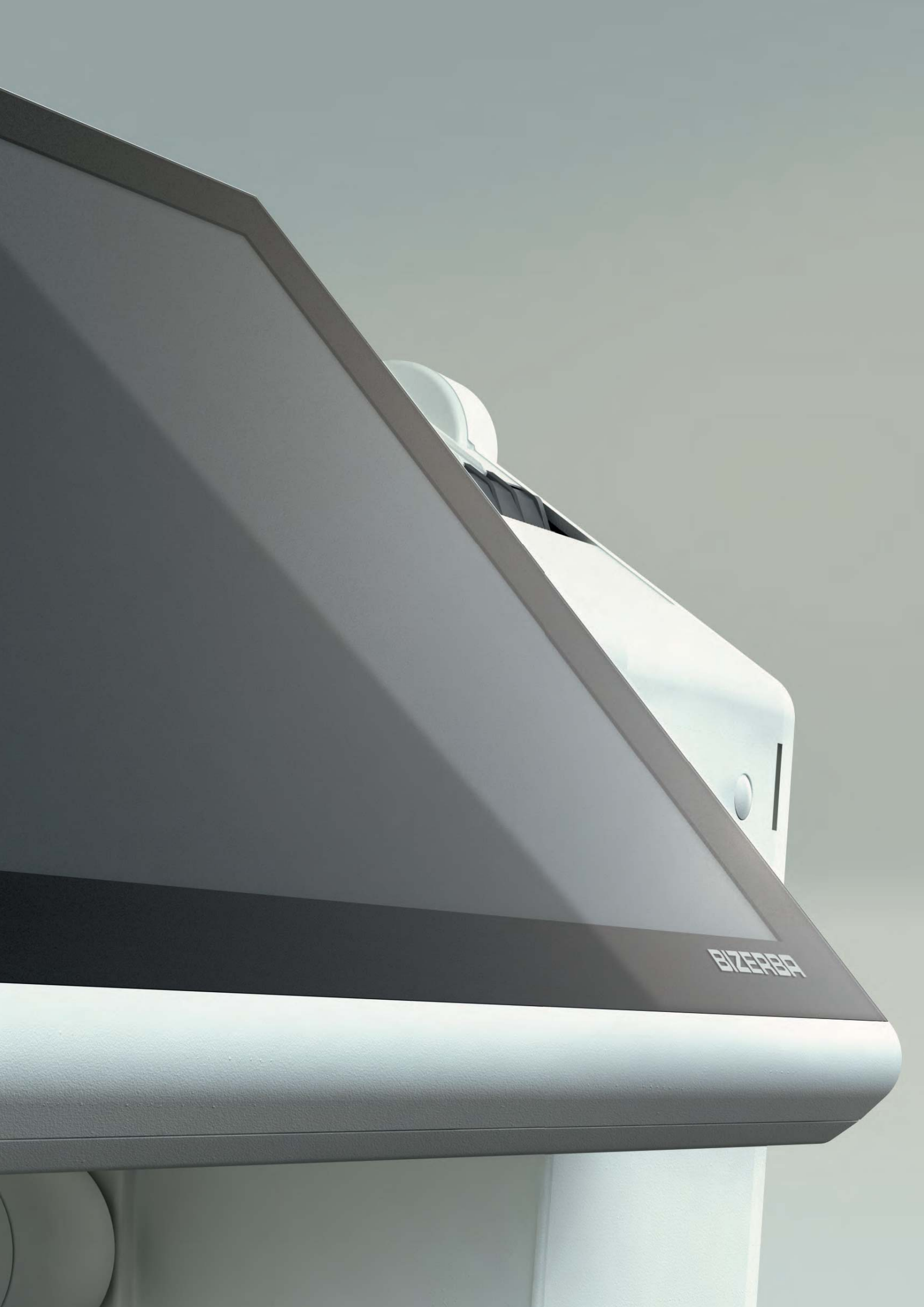

BIZERBA

# EFFICIENCY + INVESTMENT SECURITY

---

WITH THE NEW K-CLASS, WE HAVE NOT ONLY DEVELOPED A VISUALLY IMPRESSIVE SCALE WHICH ACHIEVES THE PERFECT COMBINATION OF DESIGN AND FUNCTIONALITY.

**K***class*

---

By using high-quality materials in such an aesthetically pleasing and ergonomic way, we have once again set new standards – just as we do by consistently applying the principles of open weighing technology.

As one of the most powerful touchscreen scales in the world, the new K-Class represents the pinnacle of efficient use of technology as well as long-term investment security.

The new K-Class brings together all essential retail tasks – weighing, payment transactions, promotions,

printing, advising – it's all possible. And everything is done so smoothly and reliably that it is hard to imagine a more satisfactory tool for daily operations.

Based on a uniform, modular design and available in a wide range of different models and options, the new K-Class is a prime example of technical feasibility meeting economic sense.

# K-CLASS KH II 800

The new K-Class touchscreen scale is a revolution at the service counter. It is a key step towards intelligent technology, which takes care of standard activities and hence noticeably lightens a sales employee's workload: it automatically improves the competence and performance of the person behind the counter.

Thanks to the software on the inside, the devices can be customized to handle an immense range of tasks. And that is precisely the aim of Bizerba's engineers: to develop solutions which go a step further than all the others – solutions which deliver convincing performance and are remarkably simple to work with. Technology which is hygienically clean, ensures maximum safety and yet has extremely low requirements in terms of electricity, care and maintenance.



## EASY CLEAN

- Frameless display
- One-piece housing design
- Very easy to clean
- Resistant to dirt, fingerprints, labels and damage
- Long-lasting flawless appearance



## GREEN IT

- High performance at low level of power consumption (no fan)
- Economical components (SSD, LED backlighting)
- Highly efficient power unit
- Wake On LAN



## INNER VALUES

- Modern Dual Core processor
- Fast SSD mass storage, DDR3 RAM
- Excellent graphics
- Highspeed interfaces





### EASY LOAD

- Quick and easy paper insertion in the new ticket / linerless printer
- Paper widths up to 80 mm, roll lengths up to 80 m, printing speed up to 150 mm/s
- Label layouts can be printed on pre-printed linerless paper



### SOFTWARE

- Platform for:
- .RetailPowerScale
  - .RetailControl
  - .RetailConnect
  - .RetailImpact
  - .RetailApps
  - .RetailIntegratorsKit



### EASY LEVEL\*

- Recognizes if the scale is on an unlevel surface
- Automatically corrects the weighing value
- No loss of revenue if the scale is not level

\* for more details, see the table on the inside back cover

# THE FRUITS OF OUR LABOR



## EASY CLEAN

All housing surfaces are dirt-repellent, extremely stable and corrosion-resistant, and they comply with the toughest international hygiene guidelines. Thanks to the innovative surface coating, stray labels can be removed easily – and even stubborn food residues can simply be wiped away.

The customer and operator monitors are integrated framelessly into the housing to form a completely smooth transition between housing and screen. This prevents dirt gathering there, which would later have to be arduously removed. As a result, the Easy Clean displays not only look particularly stylish but also offer a number of important practical benefits.

## INNER VALUES

On the inside, there is an integrated computer with a particularly high-performance Intel® processor, underlining the fact that these systems should no longer be called 'scales' but rather 'PCs'. In fact, combined with the revolutionary Bizerba software .RetailPowerScale, the system represents a state-of-the-art, high-tech workstation of the best possible quality. Thanks to its open technology, the K-class can be integrated into an existing IT environment.

## .RETAILAPPS

.RetailApps are true masters in flexibility, adapting to meet specific customer requirements. An individual .RetailApp is developed for each customer need and simply connected to the .RetailPowerScale scale software via standardized docking interfaces. That saves valuable development time and money, plus it provides investment security in terms of servicing and maintenance.





## **.RETAILPOWERSCALE**

.RetailPowerScale offers an all-in-one solution for food retailers of all shapes and sizes. Whether for small, specialist store-owners or the world's top 100 grocery retailers, .RetailPowerScale is the key that transforms the PC-based scale into a multi-functional device. The modular .RetailApps mean that new functions can be added quickly and easily. The functionality can be scaled up or down precisely as needed, and even the layout details can be adapted. Hence, individuality is combined with all the advantages of standard software, seamlessly integrated into the existing IT infrastructure. Operating costs are reduced and sales are increased – all thanks to .RetailPowerScale. Furthermore, the carefully considered use of both the operator display and the customer display, which can be addressed separately, offers unparalleled sales opportunities at the Point of Service.

## **EASY LEVEL**

This automatic tilt compensation eliminates weighing errors. These can otherwise be commonplace, such as when the scale is in mobile use or is placed on an unlevel surface. Thanks to the Easy Level technology, the angle of tilt is measured and compensated automatically, thus guaranteeing that the correct weight value is displayed.

## **EASY LOAD**

A new printer that really does its name justice – because although it can handle virtually all standard types of paper, the rolls can be exchanged amazingly quickly. From ticket printing on two or three-inch rolls with paper widths of up to 80 millimeters through the use of linerless paper right up to label printing – anything is possible, and the convenient handling saves valuable time. Plus the double printer allows the customer to use different types of paper simultaneously.



# KH II 800 12,1"

## HIGHLIGHTS

- Easy Clean for quick and easy cleaning of the scale
  - surface: problem free removal of stray labels
  - displays: frameless for maximum cleaning efficiency
  - load plate: optimum ease of handling
- Easy Load enables paper rolls to be changed in a matter of seconds
  - Combi-printer with ticket and linerless operation up to 80 mm paper roll widths
  - Additional label layout possible on pre-printed linerless paper
- Label and double printer\*
  - Paper near end function\* (alert when almost out of paper for unattended scales in self-service use)
- Easy Level tilt compensation\*
  - Accurate weighing results even when the scale is not leveled, no loss of revenue
- High-end PC-based scale with outstanding Intel® Dual Core processor for optimum performance and perfect graphics with minimum power consumption
- High-end software package
  - .Retail Framework
    - .RetailPowerScale scale software
    - .RetailApps for additional functionality
    - .RetailIntegratorsKit (RIK) for 3rd-party software

*Plus many more software options for additional solutions.*

## \*OPTIONEN

- Easy Level tilt compensation
- Double printer
- Various weighing ranges
- Additional COM interface in conjunction with interface for cash drawer
- Cash drawer
- Paper near end function (alert when almost out of paper)
- WLAN
- Audio kit (internal speaker)

## DIMENSIONS

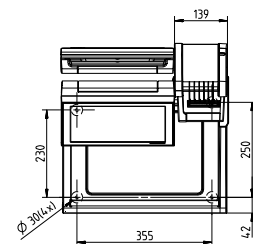
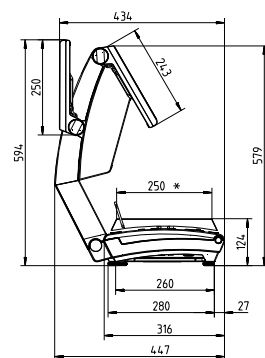
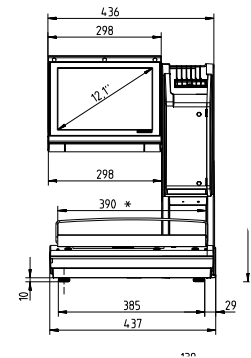

KH II 800 12,1"



# KH II 800 7''

## HIGHLIGHTS

- Easy Clean for quick and easy cleaning of the scale
  - surface: problem free removal of stray labels
  - displays: frameless for maximum cleaning efficiency
  - load plate: optimum ease of handling
- Easy Load enables paper rolls to be changed in a matter of seconds
  - Combi-printer with ticket and linerless operation up to 80 mm paper roll widths
  - Additional label layout possible on pre-printed linerless paper
- Label and double printer\*
  - Paper near end function\* (alert when almost out of paper for unattended scales in self-service use)
- Easy Level tilt compensation\*
  - Accurate weighing results even when the scale is not leveled, no loss of revenue
- High-end PC-based scale with outstanding Intel® Dual Core processor for optimum performance and perfect graphics with minimum power consumption
- High-end software package
  - .Retail Framework
    - .RetailPowerScale scale software
    - .RetailApps for additional functionality
    - .RetailIntegratorsKit (RIK) for 3rd-party software

*Plus many more software options for additional solutions.*

## \*OPTIONEN

- Easy Level tilt compensation
- Double printer
- Various weighing ranges
- Additional COM interface in conjunction with interface for cash drawer
- Cash drawer
- Paper near end function (alert when almost out of paper)
- WLAN
- Audio kit (internal speaker)

## DIMENSIONS

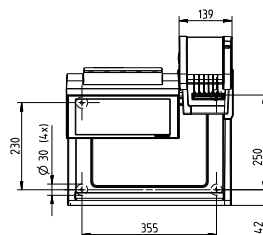
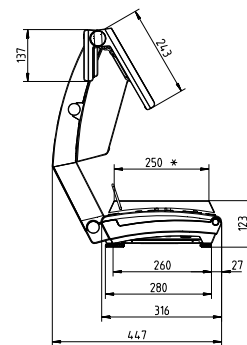
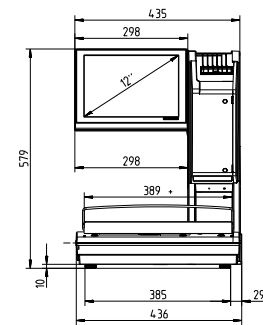



# KH II 800 SB

## HIGHLIGHTS

- Selfservice scale
- Easy Clean for quick and easy cleaning of the scale
  - surface: problem free removal of stray labels
  - displays: frameless for maximum cleaning efficiency
  - load plate: optimum ease of handling
- Easy Load enables paper rolls to be changed in a matter of seconds
  - Combi-printer with ticket and linerless operation up to 80 mm paper roll widths
  - Additional label layout possible on pre-printed linerless paper
- Labelprinter\*
  - Paper near end function\* (alert when almost out of paper for unattended scales in self-service use)
- Easy Level tilt compensation\*
  - Accurate weighing results even when the scale is not leveled, no loss of revenue
- High-end PC-based scale with outstanding Intel® Dual Core processor for optimum performance and perfect graphics with minimum power consumption
- High-end software package
  - .Retail Framework
    - .RetailPowerScale scale software
    - .RetailApps for additional functionality
    - .RetailIntegratorsKit (RIK) for 3rd-party software

*Plus many more software options for additional solutions.*

## \*OPTIONEN

- Easy Level tilt compensation
- Various weighing ranges
- Additional COM interface in conjunction with interface for cash drawer
- Cash drawer
- Paper near end function (alert when almost out of paper)
- WLAN
- Audio kit (internal speaker)

## DIMENSIONS

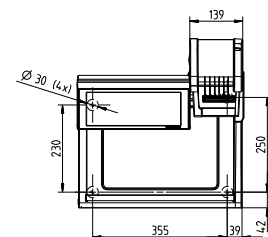
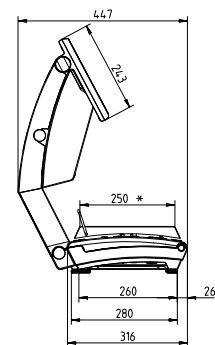
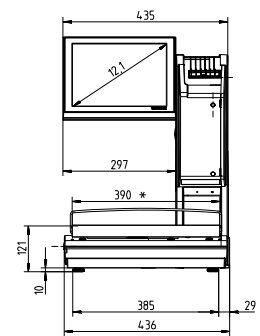



# KH II 800 SV

## HIGHLIGHTS

- Selfservice scale, camera for article recognition for fruit and vegetables
- Easy Clean for quick and easy cleaning of the scale
  - surface: problem free removal of stray labels
  - displays: frameless for maximum cleaning efficiency
  - load plate: optimum ease of handling
- Easy Load enables paper rolls to be changed in a matter of seconds
  - Combi-printer with ticket and linerless operation up to 80 mm paper roll widths
  - Additional label layout possible on pre-printed linerless paper
- Labelprinter\*
  - Paper near end function\* (alert when almost out of paper for unattended scales in self-service use)
- Easy Level tilt compensation\*
  - Accurate weighing results even when the scale is not leveled, no loss of revenue
- High-end PC-based scale with outstanding Intel® Dual Core processor for optimum performance and perfect graphics with minimum power consumption
- High-end software package
  - .Retail Framework
    - .RetailPowerScale scale software
    - .RetailApps for additional functionality
    - .RetailIntegratorsKit (RIK) for 3rd-party software

*Plus many more software options for additional solutions.*

## \*OPTIONEN

- Easy Level tilt compensation
- Various weighing ranges
- Additional COM interface in conjunction with interface for cash drawer
- Cash drawer
- Paper near end function (alert when almost out of paper)
- WLAN
- Audio kit (internal speaker)

## DIMENSIONS

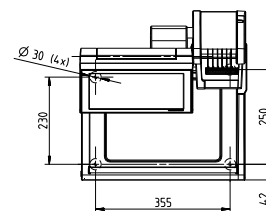
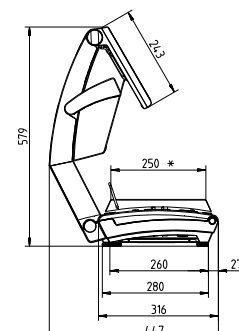
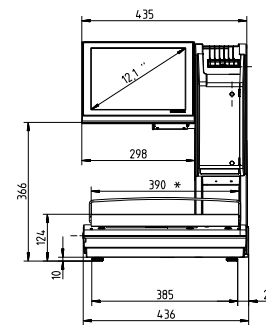



# KH II 800 12,1" SP

## HIGHLIGHTS

- Very compact solution with a short stand. Ideal for a cash drawer.
- Easy Clean for quick and easy cleaning of the scale
  - surface: problem free removal of stray labels
  - displays: frameless for maximum cleaning efficiency
  - load plate: optimum ease of handling
- Easy Load enables paper rolls to be changed in a matter of seconds
  - Combi-printer with ticket and linerless operation up to 80 mm paper roll widths
  - Additional label layout possible on pre-printed linerless paper
- Label and double printer\*
  - Paper near end function\* (alert when almost out of paper for unattended scales in self-service use)
- Easy Level tilt compensation\*
  - Accurate weighing results even when the scale is not leveled, no loss of revenue
- High-end PC-based scale with outstanding Intel® Dual Core processor for optimum performance and perfect graphics with minimum power consumption
- High-end software package
  - .Retail Framework
    - .RetailPowerScale scale software
    - .RetailApps for additional functionality
    - .RetailIntegratorsKit (RIK) for 3rd-party software

*Plus many more software options for additional solutions.*

## \*OPTIONEN

- Easy Level tilt compensation
- Double printer
- Various weighing ranges
- Additional COM interface in conjunction with interface for cash drawer
- Cash drawer
- Paper near end function (alert when almost out of paper)
- WLAN
- Audio kit (internal speaker)

## DIMENSIONS

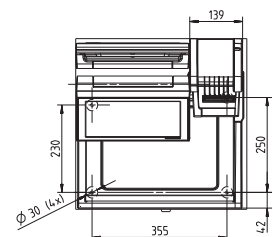
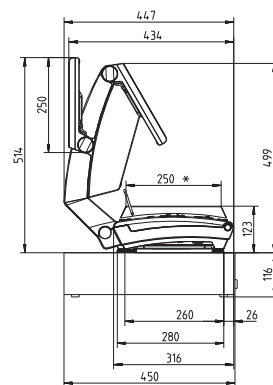
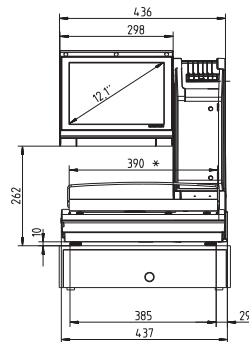

KH II 800 12,1" SP



# KH II 400 12,1"

## HIGHLIGHTS

- Hanging scale for fresh counter
  - Easy Clean for quick and easy cleaning of the scale
    - surface: problem free removal of stray labels
    - displays: frameless for maximum cleaning efficiency
    - load plate: optimum ease of handling
  - Easy Load enables paper rolls to be changed in a matter of seconds
    - Combi-printer with ticket and linerless operation up to 80 mm paper roll widths
    - Additional label layout possible on pre-printed linerless paper
  - Label and double printer\*
    - Paper near end function\* (alert when almost out of paper for unattended scales in self-service use)
  - High-end PC-based scale with outstanding Intel® Dual Core processor for optimum performance and perfect graphics with minimum power consumption
  - High-end software package
    - .Retail Framework
      - .RetailPowerScale scale software
      - .RetailApps for additional functionality
      - .RetailIntegratorsKit (RIK) for 3rd-party software
- Plus many more software options for additional solutions.*

## \*OPTIONEN

- Double printer
- Various weighing ranges
- Additional COM interface in conjunction with interface for cash drawer
- Cash drawer
- Paper near end function (alert when almost out of paper)
- WLAN
- Audio kit (internal speaker)

## DIMENSIONS

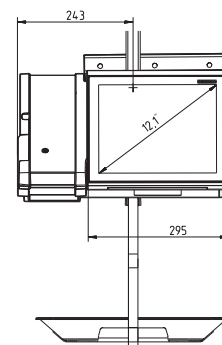
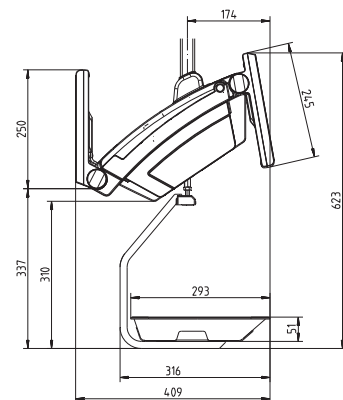
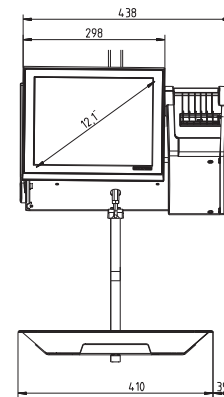

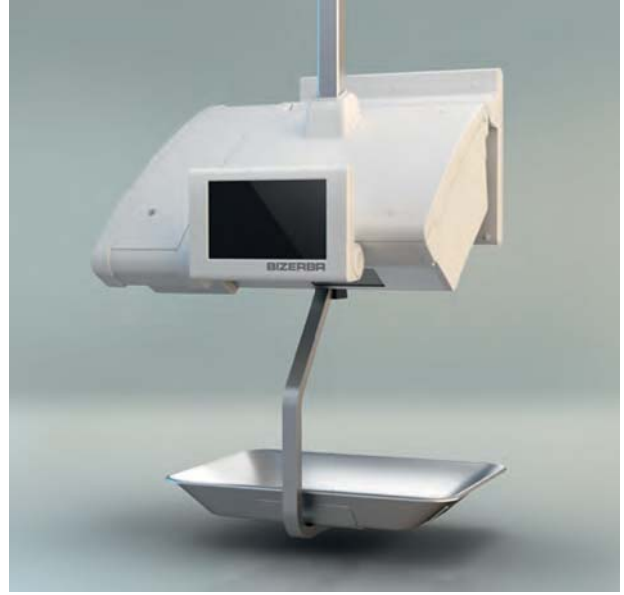

# KH II 400 7"

## HIGHLIGHTS

- Easy Clean for quick and easy cleaning of the scale
  - surface: problem free removal of stray labels
  - displays: frameless for maximum cleaning efficiency
  - load plate: optimum ease of handling
- Easy Load enables paper rolls to be changed in a matter of seconds
  - Combi-printer with ticket and linerless operation up to 80 mm paper roll widths
  - Additional label layout possible on pre-printed linerless paper
- Label and double printer\*
  - Paper near end function\* (alert when almost out of paper for unattended scales in self-service use)
- High-end PC-based scale with outstanding Intel® Dual Core processor for optimum performance and perfect graphics with minimum power consumption
- High-end software package
  - .Retail Framework
  - .RetailPowerScale scale software
  - .RetailApps for additional functionality
  - .RetailIntegratorsKit (RIK) for 3rd-party software

*Plus many more software options for additional solutions.*

## \*OPTIONEN

- Double printer
- Various weighing ranges
- Additional COM interface in conjunction with interface for cash drawer
- Cash drawer
- Paper near end function (alert when almost out of paper)
- WLAN
- Audio kit (Internal speaker)

## DIMENSIONS

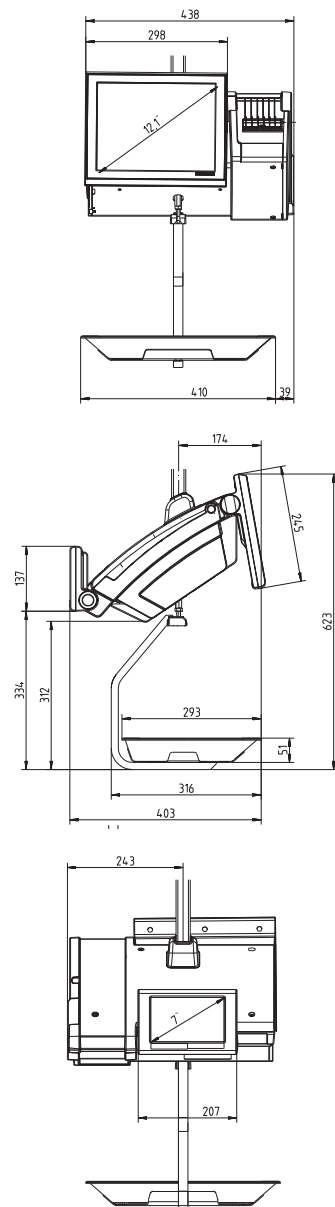

KH II 400 7"





# KH II 200 12,1"

## HIGHLIGHTS

- Easy Clean for quick and easy cleaning of the scale
  - surface: problem free removal of stray labels
  - displays: frameless for maximum cleaning efficiency
  - load plate: optimum ease of handling
- Easy Load enables paper rolls to be changed in a matter of seconds
  - Combi-printer with ticket and linerless operation up to 80 mm paper roll widths
  - Additional label layout possible on pre-printed linerless paper
- Label printer\*
  - Paper near end function\* (alert when almost out of paper for unattended scales in self-service use)
- Easy Level tilt compensation\*
  - Accurate weighing results even when the scale is not leveled, no loss of revenue
- High-end PC-based scale with outstanding Intel® Dual Core processor for optimum performance and perfect graphics with minimum power consumption
- High-end software package
  - .Retail Framework
    - .RetailPowerScale scale software
    - .RetailApps for additional functionality
    - .RetailIntegratorsKit (RIK) for 3rd-party software

*Plus many more software options for additional solutions.*

## \*OPTIONEN

- Easy Level tilt compensation
- Various weighing ranges
- Additional COM interface in conjunction with interface for cash drawer
- Cash drawer
- Paper near end function (alert when almost out of paper)
- WLAN
- Audio kit (Internal speaker)

## DIMENSIONS

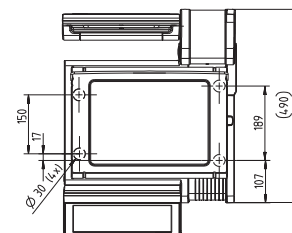
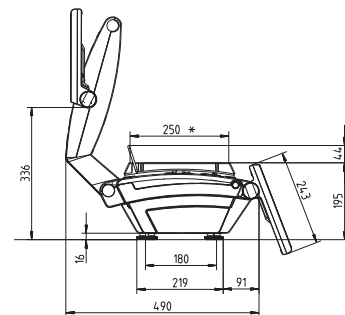
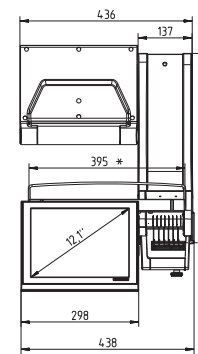



# KH II 200 7"

## HIGHLIGHTS

- Easy Clean for quick and easy cleaning of the scale
    - surface: problem free removal of stray labels
    - displays: frameless for maximum cleaning efficiency
    - load plate: optimum ease of handling
  - Easy Load enables paper rolls to be changed in a matter of seconds
    - Combi-printer with ticket and linerless operation up to 80 mm paper roll widths
    - Additional label layout possible on pre-printed linerless paper
  - Label printer\*
    - Paper near end function\* (alert when almost out of paper for unattended scales in self-service use)
  - Easy Level tilt compensation\*
    - Accurate weighing results even when the scale is not leveled, no loss of revenue
  - High-end PC-based scale with outstanding Intel® Dual Core processor for optimum performance and perfect graphics with minimum power consumption
  - High-end software package
    - .Retail Framework
      - .RetailPowerScale scale software
      - .RetailApps for additional functionality
      - .RetailIntegratorsKit (RIK) for 3rd-party software
- Plus many more software options for additional solutions.*

## \*OPTIONEN

- Easy Level tilt compensation
- Various weighing ranges
- Additional COM interface in conjunction with interface for cash drawer
- Cash drawer
- Paper near end function (alert when almost out of paper)
- WLAN
- Audio kit (Internal speaker)

## DIMENSIONS

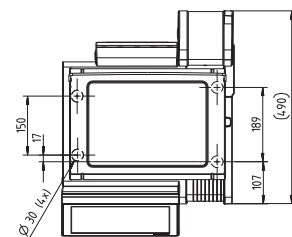
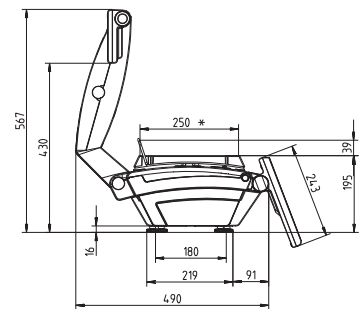
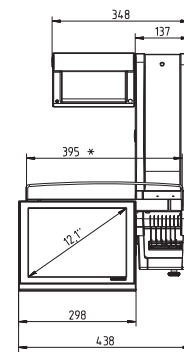

KH II 200 7"



# KH II 100 7"

## HIGHLIGHTS

- Easy Clean for quick and easy cleaning of the scale
  - surface: problem-free removal of stray labels
  - displays: frameless for maximum cleaning efficiency
  - load plate: optimum ease of handling
- Easy Load enables paper rolls to be changed in a matter of seconds
  - Combi-printer with ticket and linerless operation up to 80 mm paper roll widths
  - Additional label layout possible on pre-printed linerless paper
- Label and double printer\*
  - Paper near end function\* (alert when almost out of paper for unattended scales in self-service use)
- Easy Level tilt compensation\*
  - Accurate weighing results even when the scale is not leveled, no loss of revenue
- High-end PC-based scale with outstanding Intel® Dual Core processor for optimum performance and perfect graphics with minimum power consumption
- High-end software package
  - .Retail Framework
    - .RetailPowerScale scale software
    - .RetailApps for additional functionality
    - .RetailIntegratorsKit (RIK) for 3rd-party software

*Plus many more software options for additional solutions.*

## \*OPTIONEN

- Easy Level tilt compensation
- Double printer
- Various weighing ranges
- Separate load receptor up to 150 kg (KH II 100 G)
- Additional COM interface in conjunction with interface for cash drawer
- Cash drawer
- Paper near end function (alert when almost out of paper)
- WLAN
- Audio kit (internal speaker)

## DIMENSIONS

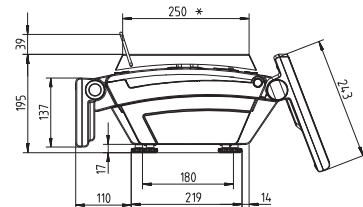
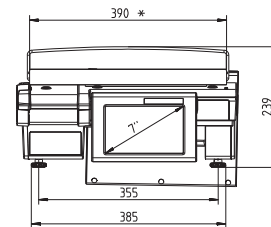
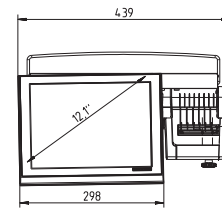

KH II 100 7"



# KH II 100 7" B

## HIGHLIGHTS

- Easy Clean for quick and easy cleaning of the scale
  - surface: problem-free removal of stray labels
  - displays: frameless for maximum cleaning efficiency
  - load plate: optimum ease of handling
- Easy Load enables paper rolls to be changed in a matter of seconds
  - Combi-printer with ticket and linerless operation up to 80 mm paper roll widths
  - Additional label layout possible on pre-printed linerless paper
- Labelprinter
  - Paper near end function\* (alert when almost out of paper for unattended scales in self-service use)
- Easy Level tilt compensation\*
  - Accurate weighing results even when the scale is not leveled, no loss of revenue
- High-end PC-based scale with outstanding Intel® Dual Core processor for optimum performance and perfect graphics with minimum power consumption
- High-end software package
  - .Retail Framework
    - .RetailPowerScale scale software
    - .RetailApps for additional functionality
    - .RetailIntegratorsKit (RIK) for 3rd-party software

*Plus many more software options for additional solutions.*

## \*OPTIONEN

- Various weighing ranges
- Separate load receptor up to 150 kg (KH II 100 G)
- Additional COM interface in conjunction with interface for cash drawer
- Cash drawer
- Paper near end function (alert when almost out of paper)
- WLAN
- Audio kit (internal speaker)

## DIMENSIONS

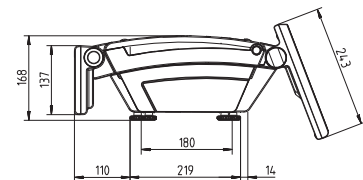
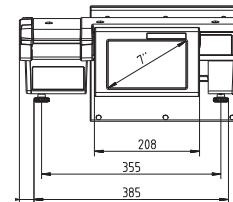
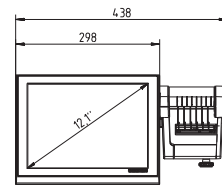

# INFORMATION TO SUIT YOUR EVERY NEED

---

THERE ARE VARIOUS QUICK AND EFFECTIVE ROUTES TO FINDING THE PERFECT SOLUTION FOR YOUR COMPANY. WHETHER YOU WOULD LIKE TO CONTACT US ONLINE OR PREFER TO ARRANGE A FACE-TO-FACE MEETING, BIZERBA IS ALWAYS HAPPY TO HELP.

---

## **IN PERSON**

If you would like to set up a personal meeting to discuss your on-site circumstances and possibilities, please contact us directly. Our customer advisors are always on hand to assist you, from the initial idea to detailed planning and from implementation to staff training. You can find details of how to contact us on the back page of this brochure.

.....

## **ONLINE**

The Bizerba website provides a quick, easy and focused overview of all our product solutions as well as relevant topics relating to weighing, packaging, pricing and

labeling. You can even experience our solutions from all angles 'virtually' for yourself thanks to videos and 360° animations. Simply visit our website to see more:

**[www.bizerba.com](http://www.bizerba.com)**

.....

## **WOULD YOU LIKE TO KNOW MORE?**

Are you keen to obtain more detailed information about Bizerba's products? If so, please do not hesitate to contact us. Whether you require scale drawings, technical details or interface specifications, we're happy to advise you.

PRODUCT	IDEAL FOR							FOR WHAT PURPOSE?					
	SAUSAGES	MEAT	CHEESE	FISH	FRUIT & VEGETABLES	BREAD	NON-FOOD	COUNTER SERVICE	SELF SERVICE	PRICE LABELING / PRE-PACKING	GOODS IN / PICKING	MULTIMEDIA PURPOSES	CHECKOUT
<b>COUNTER SCALE stand</b>													
KH II 800 with 7"	●	●	●	●	●	●	●	●	⊖	●	●	⊖	⊖
KH II 800 with 12,1"	●	●	●	●	●	●	●	●	⊖	●	●	●	⊖
KH II 800 with 7" SP <i>with short stand</i>	●	●	●	●	●	●	●	●	⊖	●	●	⊖	●
KH II 800 with 12,1" SP <i>with short stand</i>	●	●	●	●	●	●	●	●	⊖	●	●	●	●
KH II 800 SB	×	×	×	×	●	×	●	×	●	⊖	⊖	⊖	⊖
KH II 800 SV	×	×	×	×	●	×	⊖	×	●	⊖	⊖	⊖	⊖
<b>COUNTER-TOP SCALE</b>													
KH II 100 with 7"	●	●	●	●	●	●	●	●	⊖	●	●	⊖	●
KH II 100 7" B	×	×	×	×	×	●	●	●	×	●	×	⊖	●
KH II 100 7" G <i>separate load receptor</i>	⊖	⊖	⊖	⊖	●	●	●	●	⊖	●	●	⊖	●
KH II 100 SB	×	×	×	×	●	×	●	×	●	⊖	⊖	⊖	⊖
<b>COUNTER-TOP SCALE customer display on a stand</b>													
KH II 200 with 7"	●	●	●	●	●	●	●	●	⊖	●	●	⊖	●
KH II 200 with 12,1"	●	●	●	●	●	●	●	●	⊖	●	●	●	●
<b>HANGING SCALE</b>													
KH II 400 with 7"	⊖	⊖	⊖	●	●	⊖	⊖	●	⊖	●	⊖	⊖	●
KH II 400 with 12,1"	⊖	⊖	⊖	●	●	⊖	⊖	●	⊖	●	⊖	●	●

**KEY**

- Optimally suitable for this purpose
- ⊖ Suitable for this purpose
- ×

WHERE?

FEATURES

OPTIONS

	FOOD RETAIL	SPECIALIST FOOD RETAILERS	DELICATESSENS	FOOD SERVICE / SNACK BARS	DIY STORES	MOBILE TRADERS	EASY CLEAN-DISPLAY	EASY-FIT LOAD PLATE	EASY-LOAD PRINTER	DOUBLE PRINTER	EASY LEVEL	CASH DRAWER INTERFACE	WLAN	SEPARATE LOAD RECEPTOR UP TO 150 KG	PAPER NEAR END FUNCTION
	●	●	●	●	●	●	●	●	●	●	●	⊖	●	×	●
	●	●	●	●	●	●	●	●	●	●	●	⊖	●	×	●
	⊖	●	●	●	●	●	●	●	●	●	●	●	●	×	●
	⊖	●	●	●	●	●	●	●	●	●	●	●	●	×	●
	●	⊖	⊖	×	●	×	●	●	×	●	●	⊖	●	×	●
	●	⊖	⊖	×	⊖	×	●	●	×	●	●	⊖	●	×	●
	●	●	●	●	●	●	●	●	●	●	●	●	●	×	●
	●	●	●	●	●	●	●	●	×	●	×	●	●	×	●
	●	●	⊖	●	●	●	●	●	×	●	×	●	●	●	●
	●	⊖	⊖	×	●	×	●	●	×	●	⊖	●	●	×	●
	●	●	●	●	●	●	●	●	×	●	●	●	●	×	●
	●	●	●	●	●	●	●	●	×	●	●	●	●	×	●
	●	●	●	⊖	⊖	⊖	●	×	●	×	⊖	●	×	●	
	●	●	●	⊖	⊖	⊖	●	×	●	×	⊖	●	×	●	

## MEMBERS OF THE BIZERBA GROUP

Bizerba GmbH & Co. KG  
Wilhelm-Kraut-Straße 65  
72336 Balingen  
Germany

Tel: +49 7433 12-0  
Fax: +49 7433 12-2696  
marketing@bizerba.com

[www.bizerba.com](http://www.bizerba.com)

Bizerba USA Inc.  
1804 Fashion Court  
Joppa, MD 21085  
USA

Tel: Office +1 732 565-6000  
Tel: Service +1 732 565-6001  
Fax: +1 732 819-0429  
us.info@bizerba.com

[www.bizerbausa.com](http://www.bizerbausa.com)

Bizerba UK Limited  
2-4 Erica Road  
Stacey Bushes  
Milton Keynes  
Buckinghamshire  
MK12 6HS  
U.K.

Tel: +44 1908 682740  
Fax: +44 1908 682777  
sales@bizerba.co.uk

[www.bizerba.com](http://www.bizerba.com)

Bizerba Canada Inc.  
2810 Argentia Road #9  
Mississauga,  
Ontario L5N 8L2  
Canada

Tel: +1 905 816-0498  
Fax: +1 905 816-0497  
ca.info@bizerba.com

[www.bizerba.ca](http://www.bizerba.ca)

Bizerba (Shanghai)  
Weigh Tech & Systems Co.Ltd.  
D-3, Qianpu Road,  
Shuhui Real Est.Park  
East New Area of Songjiang,  
Ind.Zone  
201611 Shanghai  
China

Tel: +86 (21) 67 60 09 99  
Fax: +86 (21) 67 60 09 98  
marketing.china@bizerba.cn

[www.bizerba.cn](http://www.bizerba.cn)

I/805d © 1st edition. All rights reserved. 051340

*The publisher accepts no liability for printing errors or color variations as a result of image quality or the printing process, and reserves the right to make structural or technical modifications.*